

Cable layout and CAN transceivers for higher bit rates

Kent Lennartsson (Kvaser)

A higher bitrate makes the bits more sensitive to the cable layout. The number of drop lines, the length of the drop lines, the unit impedance and the spread of the drop lines, all together sets the limits for the usable bitrate. This paper will describe how and why those factors effects the signal propagation. There will be some rules of thumbs to follow. One part will show how much that can be gained by using CAN SIC drivers or CAN-XL SIC drivers.

Historically CAN has been used below 0.5 Mbit/s even though it was designed for 1 Mbit/s. CAN's main cable problem has been the signal propagation delay which, in combination with the protocol's arbitration method, demands a propagation segment that is at least twice as long as the cable's propagation delay. This results in that Classical CAN is very robust against signal oscillation (ringing) caused by imperfections in the cable layout. The possibility to increased bitrate in CAN-FD and CAN-XL makes it individual bits more sensitive to phase-noise and inter-symbol interference, which in turn cause an amplitude noise. To succeed using higher bitrates demand more knowledge and tools to understand and secure the cable layout in use.

Conclusion

To understand and design a complex CAN-bus (CAN-network) for higher bitrates it is necessary to have tools to analyze and simulate the network. The described solution is a combination of measurements and simulations. With this combination it will be possible to include measurement results into the simulation and from simulation provide a template which can be compared with measurements on a real CAN-bus. Both the measurements and simulations are based on S-parameters. The advantage with S-parameters is that they include a perfect representation of a CAN-network as a black box even if the details are unknown. The only drawback with S-parameters is that it is hard to describe a network from the measured S-parameters. On the other hand, it is easy to make S-parameters from a simulation and compare those with measured S-parameters from a real CAN-bus.

Simulation based on S-parameters is faster because the output signal is matrix calculation based on the input signal. The main task is to calculate the S-parameters from the input to every output. This can be done once and from any type of input signal step, pulse,

PBRS, sinus, etc. to a calculate the output signal including eye diagram.

Another advantage is that it is not necessary to make a perfect model of an installed unit, because a measurement on the dropline with the node installed will provide an exact description of the signal environment caused by this object. This measurement can then be used as a black-box component in the system simulation. Such black-box representation does not directly show which type of components are involved, where they are located or their values. However, if you make a simulation model it will be possible to compare the S-parameters from a model with the measured S-parameters to check how well the model describes the real world.

The problem

A higher bitrate makes the bits more sensitive to the cable layout. The number of drop lines, the length of the drop lines, the unit impedance and the spread of the drop lines, all together set the limits for the usable bitrate. It is all about the relation between wavelength and the length of the cable in combination with the impedance variations in this cable system. Theoretically a 20-meter

CAN-bus layout at 10 Mbit/s is as complex as a 0.2-meter DDR-bus at 1Gb/s, because they have the same relation between dropline and signal wavelength. In many cases It is even harder to design a CAN-bus because the nodes are more complex with connectors and EMC-filters. This paper will describe how and why those factors affect signal propagation. Some useful rules of thumb are also going to be provided.

The dropline problem

To ensure proper signal integrity it is necessary to understand the potential problems and how to minimize their effects. The reason Point-to-Point data communication is so successful is because if the cable and connectors have continuous impedance there is no reflection.

Before we analyze complex multi-node networks it is necessary to understand the simplest network. The network in figure 1 has one receiving node with a noticeably short dropline (1 mm), with perfectly matched driver and termination. In a typical CAN network, the transmitter is at a dropline, but that complication is not covered here.

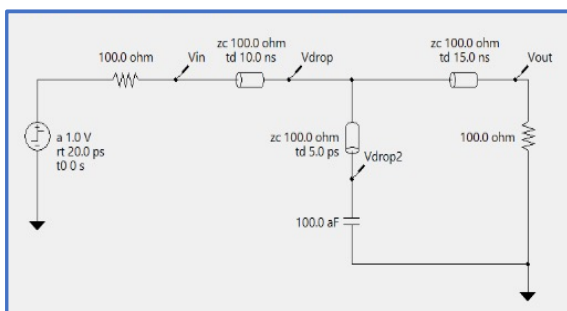

Figure 1: communication with one short dropline.

The example has a signal source to the left that in this case will make a 1-volt step. Figure 3 shows the step as Vin (blue) at the source at time 0 ns. This step will propagate through the first transmission line that provides a 10 ns delay (2-meter CAT5 cable) and the step will show up at Vdrop (orange/red) and Vdrop2 (orange/red) at 10 ns as expected. The signal will continue through the following transmission line with 15 ns delay and the step at Vout (green) occur after 25 ns.

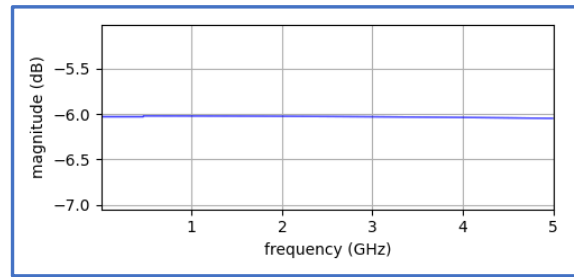

Figure 2: Frequency response graph of a 1 mm drop line.

As seen in figure 2, all frequencies up to 5 GHz are unaffected. This is a perfect transmission line and not a real CAT6e cable where you will see more loss above 1 GHz.

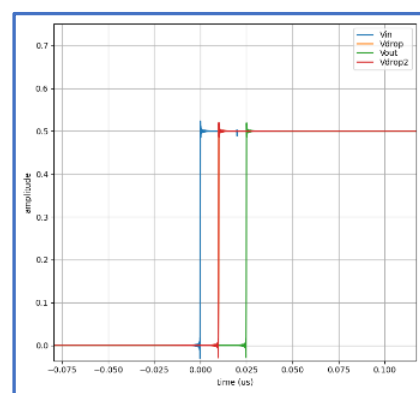

Figure 3: The signal pass through without distortion.

To show the effect of the drop line the length is increased from 1 mm (5 ps) to 1000 mm (5 ns) and all other parts of the schematic are left unchanged. This will have a significant impact on the amplitude at different frequencies as shown in Figure 4.

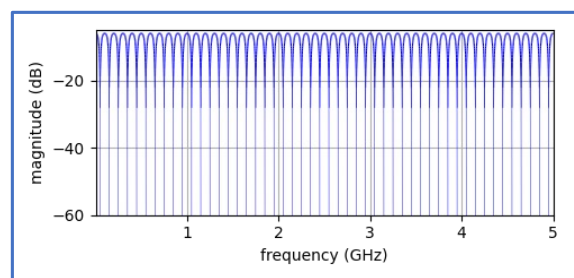

Figure 4: Frequency response graph of a 1m drop line. The 1 m drop line will block certain frequencies.

What is shown in figure 4 is related to the S-parameters called S21 which some refer to insertion loss and is the energy at Vdrop compared to the energy at Vin for different frequencies. An experienced engineer will

assume that there is an unwanted component introduced that cause resonance.

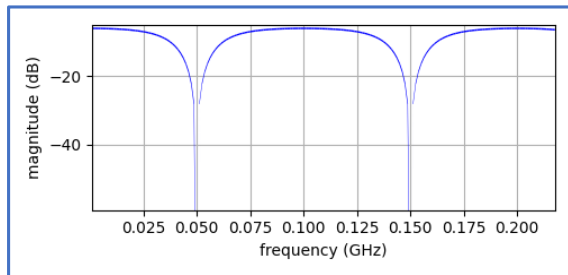

Figure 5: Same as figure 4 but zoomed in to 200 MHz.

For a CAN network running at less than 30 Mbit/s all the energy in its signal is below 100 MHz. Figure 5 shows the same frequency response as figure 4, but zoomed in to show the response between 0 to 200 MHz. The figure shows that all energy at 50 and 150 MHz is totally blocked at Vdrop as well at Vout.

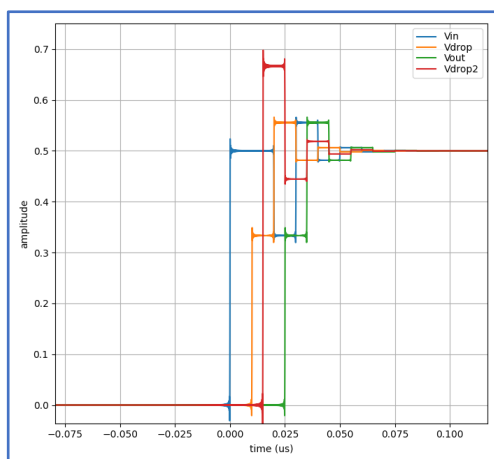

Figure 6: different signals with 1 meter dropline at 20 ps step.

The reason for the signal dampening is that the signal travels down the drop line and at the end of it the signal will be reflected without any phase change and return to the main line. When the signal comes back with 180-degree phase shift it will cancel the signal at Vdrop. The full wavelength is the drop line delay (5 ns) multiplied by 4 (20ns) and the frequency is the inverse of the length in seconds, or $1/20\text{ns} = 50\text{ MHz}$. The conclusion is that with a 1-meter drop line it is necessary to keep the CAN bus signal energy below 25 MHz. Otherwise, the signals at the different location along the CAN-bus will be overly complicated as seen in figure 6.

The reason for this behavior is beyond the scope of this paper, but of interest is that the edges of the signal are still with 20 ps steps, because the system still allow energy frequencies up to 5 GHz and only the specific frequencies at 50, 150, 250,... MHz are blocked as shown in figure 4. Even so there are a lot of reflections during a 20 ns period and that will limit the bitlength to 50 ns (20 Mbit/s). At 20 Mbit/s it is possible to reduce the step time from 20 ps to 10 ns. Doing so makes the step smoother and reduces the ringing as shown in figure 7.

The signal at Vin, Vdrop, Vdrop2 are most affected by this change. This is a general feature to remember. Most ringing occurs at the sender and the two nodes on either side of the sender. All droplines that the signal pass through will act as an LP-filter and remove high frequency energy. The transmission line has some loss that also will reduce the oscillation amplitude. The problem at the node far away from the sender is to keep the signal level to an acceptable level for correct decoding.

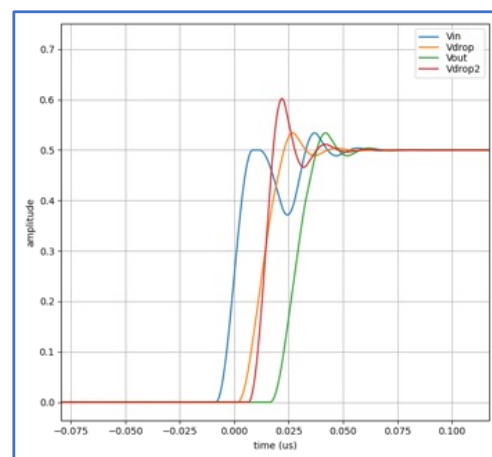

Figure 7: 1 meter drop with 10 ns step.

The obvious solution to reduce ringing is to remove high frequency energy and the simple solution is to reduce the slew-rate. The ringing will be reduced even more if a 20 ns step can be used but that will make it hard to have a bit-period shorter than 50 ns which reduce the bitrate to 20 Mbit/s or below. In this example there is only one node. In a real CAN-bus there will be several droplines along the main bus-line which will introduce more reflections and demand an even lower bitrate.

To support higher bitrates, it is necessary to build a better network and the main solution is to reduce the dropline length. In figure 8 we see the result on the signal when the dropline is reduced to 0.5 meter.

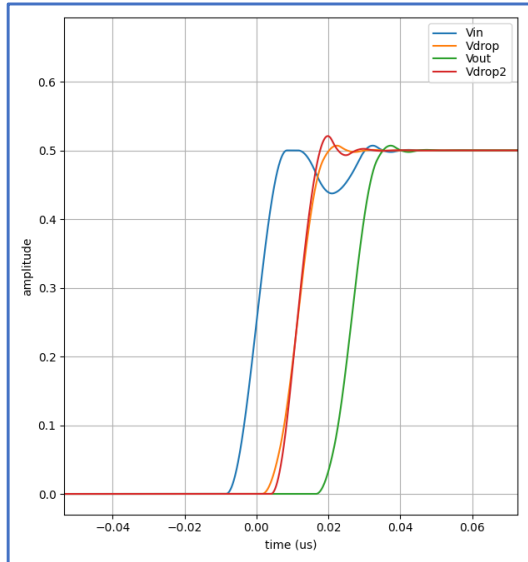

Figure 8: 0.5-meter drop line at 10ns step.

Another factor that will limit bitrate is the node connected to the end of the dropline. Between the end of the dropline and the ECU (Electronic Control Unit) there are at least connectors, PCB routing, EMC-filter, and the CAN-driver interface. Figure 9 shows the result if the capacitor value as seen in figure 1 is set to 50 pF which corresponds to the mentioned in-between components.

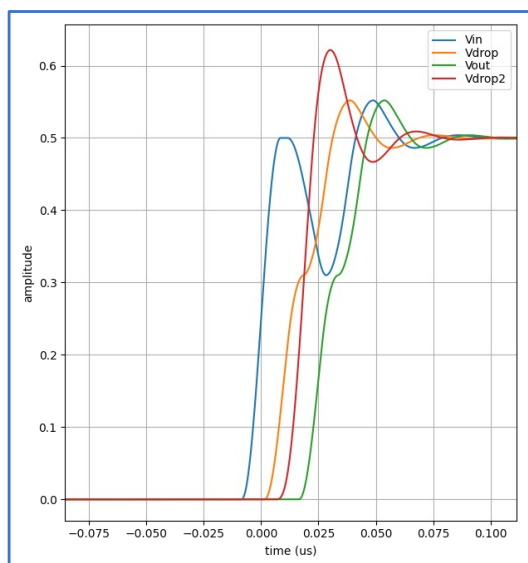

Figure 9: 1m dropline at 10 ns step and 50 pF node load.

Even a small load of 50 pF causes major ringing on the bus. This load can to some degree be compensated for by reducing the dropline. Figure 10 shows an improved signal when the dropline is reduced from 100 cm to 25 cm. The system has changed and figure 11 shows the S21 at Vdrop(2) relative to the source(1). A reduction of the dropline from 100 cm to 25 cm moves the resonance from 50 to 200 MHz as shown in figure 11 and this resonance will occur every 400 MHz [200, 400, 800, 1200, .. MHz]. When the capacitor was increased to 50 pF it will change the S21 parameters which is shown in figure 12. The capacitor moves the first resonance from 200 MHz to 61 MHz. Following the same logic as previously the 61 MHz resonance should be a 81 cm dropline followed by resonance at [183, 305, 427, .. MHz] but in figure 12 the resonance is at [61, 403, 800, .. MHz], which indicates that something is different. From 800 MHz and above we find that there is 400 MHz between the resonances, which indicates a 25 cm dropline. The resonance has been shifted 200 MHz because with a small capacitor the behaves as an open end and the signal is reflected into the dropline without phase-shift. A large capacitor will short-circuit the signal to ground which will instead reflect the energy back with a 180-degree phase-shift. This shows that it is possible to reverse engineer the network from the S-parameters if a system has few components. In this example it is easy to find out that we have a 25 cm dropline and a capacitor, but to get the value 50 pF it requires some advanced math.

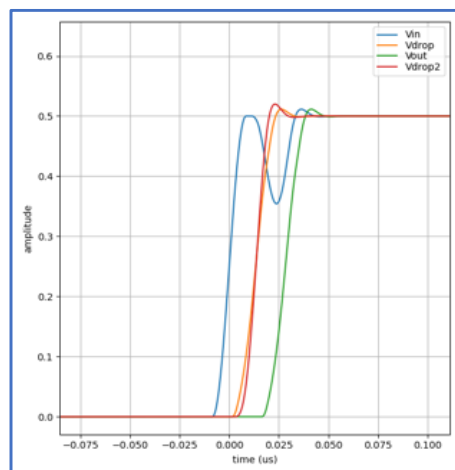

Figure 10: 25 cm dropline at 10 ns step and 50 pF load.

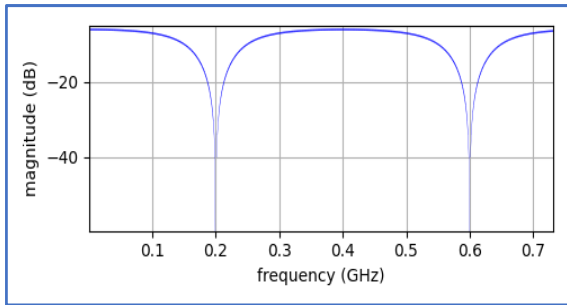

Figure 11: 25 cm dropline with capacitor at 50 aF.

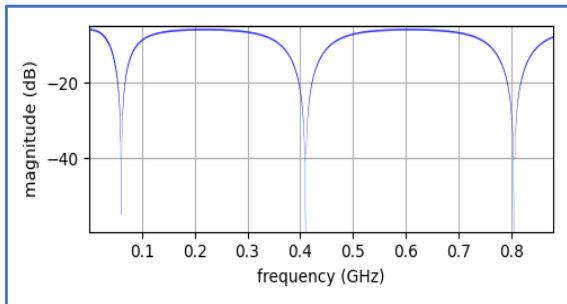

Figure 12: 25 cm dropline with 50 pF capacitor.

In previous examples there is only one node, so the next step will be to see how the signal is affected by a second dropline. The schematic is shown in figure 13. The corresponding S-parameters are shown in figure 15. It looks remarkably like the S-parameters in figure 11 with only one dropline. Both have the same resonance because they have the same length. A close comparison between Figure 12 and 15 shows a slight change in the shape between the resonances. The simulated step is shown in figure 14 and if that is compared with figure 10, the dip in V_{in} becomes much more significant. Making a star-topology with two droplines each of 100 Ohm impedance is the same as placing one dropline with 50 Ohm impedance. The current coming from the V_{in} will at V_{drop} be divided into three currents, each into three different transmission lines of 100 Ohm load, which would behave equal to a single transmission line with 33 Ohm Impedance. This abrupt change in load will cause a 180 degree phase-shifted wave back to V_{in} which will cause voltage drop at V_{in} 2*10 ns later. This in turn will cause an increased current from the source until the capacitors are filled and there is no current flow in the droplines.

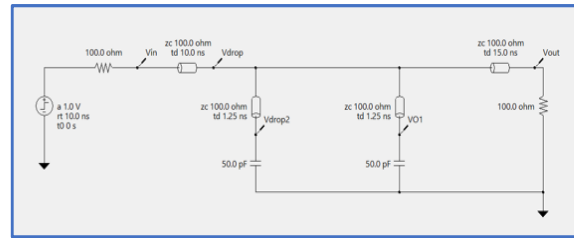

Figure 13: a small star, two 25 cm droplines.

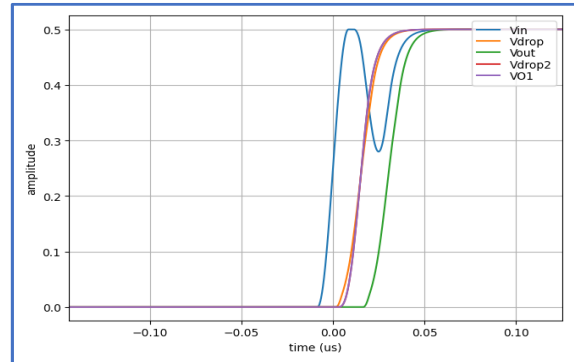

Figure 14: 2 droplines, 25 cm, 50 pF from figure 13.

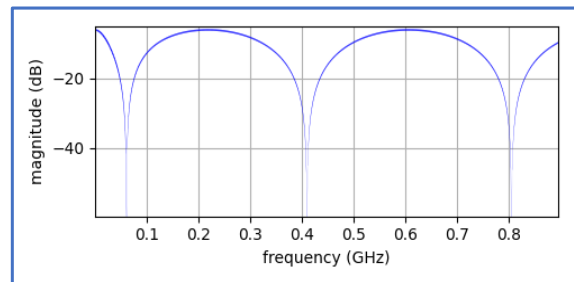

Figure 15: S12 at V_{drop} in Figure 13.

If one of the droplines is changed from 25 cm to 33 cm there will be a more complex set of resonances as shown in figure 16.

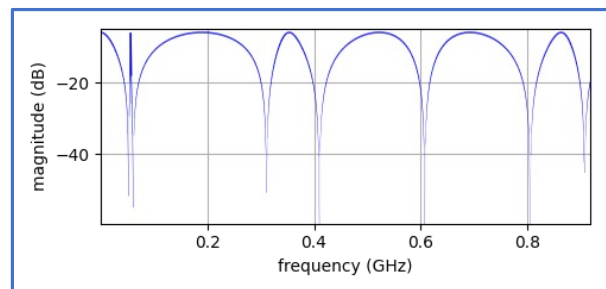

Figure 16: one dropline in figure 13 increased to 33 cm.

To get a more realistic CAN-bus is a transmission line added between the two droplines in figure 13 to get the setting as shown in Figure 17. To reduce the complexity, we keep both droplines at 25 cm with 50 pF load at the end of the two droplines.

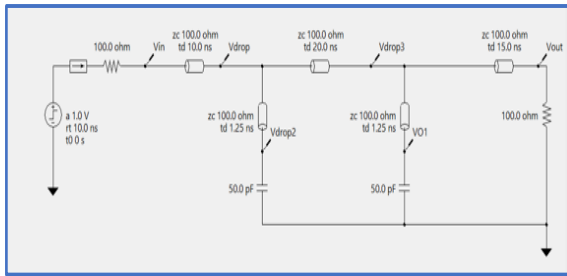

Figure 17: A 20 ns transmission line between the droplines.

Because there are two drop lines separated in time by a transmission line, we should now expect V_{in} to experience two separate drops in amplitude. This can be seen in figure 18.

At the same time as the voltage drop occurs the current from the source increases, which can be seen by the bumps in the signal at the bottom of the graph.

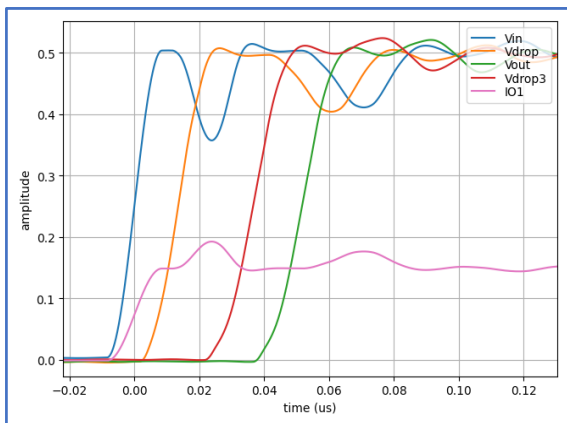

Figure 18: signals from schematic in figure 17.

The introduction of the transmission line will make a huge change in the S_{21} at V_{drop} , as seen in figure 19, compared to the S -parameters in figure 15. The overall shape is the same but with a complex ripple overlaid to its shape.

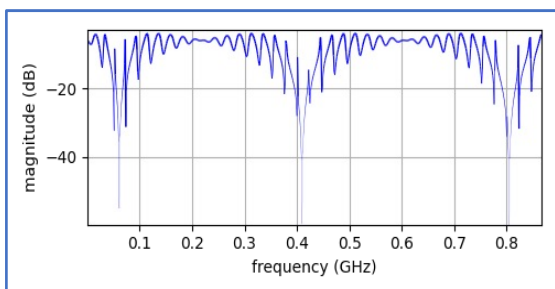

Figure 19: S_{21} at V_{drop} from schematic figure 17.

Achieved knowledge so far

From the description of the dropline problem, it is possible to list some achieved knowledge.

1. Just one dropline has a major effect on a signal energy above a certain frequency.
2. The longest dropline sets the limit for the entire system.
3. Any capacitor or inductor at the end of a dropline will increase the effect from the dropline.
4. The problem can be reduced by decreasing the slew-rate of the input signal, which removes high frequency energies. Limited slew-rate will directly limit the possible bitrate.
5. To increase the signal bandwidth, it is necessary to use short droplines and keep the capacitive load at the end of the dropline as low as possible.

If the bitrate is low enough it is possible to use any layout of the CANbus. Every bitrate has a certain maximum useful dropline. A certain length of the dropline will have a first resonance frequency as shown in figure 20. A dropline of 50 meters has a resonance at 1 MHz. At 5 meters it increases to 10 MHz and as seen from previous examples the resonance at 1 meter is 50 MHz.

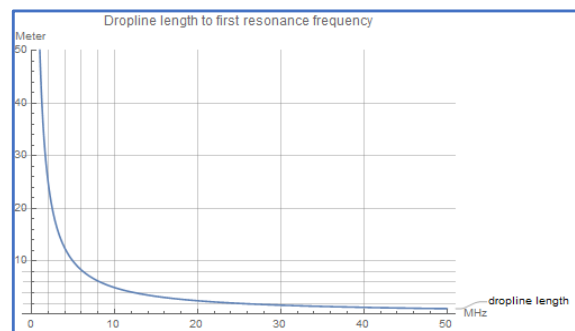

Figure 20: dropline length at different resonance frequencies (Equ 3).

A square wave signal is multiple sinewaves interposed on top of each other, of which is their fundamental frequencies are multiples of the infinite series $\{1, 3, 5, 7, \dots\}$, and which the amplitude of each gets smaller with higher frequencies. To receive a digital communication signal the first three sinus components is good enough. The simple solution to remove higher frequency components is to reduce the slew-rate. The

fundamental frequency of a square wave signal is half that of the bitrate. A bitrate of 250 kbit/s therefore have the square-wave sinewaves at 125, 375 and 625 kHz. This relation can be described by equation 1 below.

$BW > 2.5 * BR$, where BW = the necessary bandwidth (MHz);
BR the bitrate in Mbit/s. Equ 1

$BW > 2.5 * 0.250 = 0.625$ MHz.

Bandwidth is typically -3 dB, or where the voltage is reduced by 50%. As shown previously, at the resonance all energy is lost, so it is necessary to keep the third sinus element halfway from the resonance. To get the first three sinus components through the network the resonance must be about two times above the BW as shown in equation 2.

$resfreq > 5 * BR$, where BW=the necessary bandwidth (MHz);
BR the bitrate in Mbit/s. Equ 2

$resfreq > 5 * 0.250 = 1.250$ MHz.

$dropline[resfreq] = 50 (m * MHz) / resfreq(MHz)$ Equ 3

⟷

$dropline[BR] < 50 (m * MHz) / 5 * BR$ (Mbit/s) Equ 4

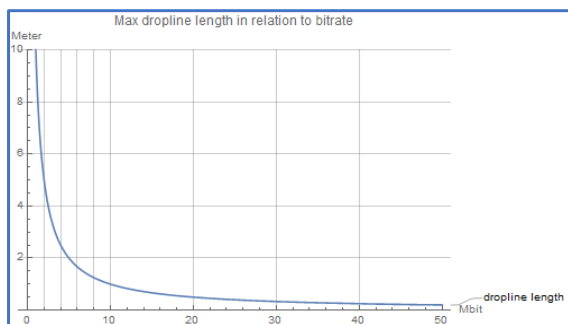

Figure 21, maximum dropline as function to bitrate (Equ 4).

The data in figure 21 is for one single node (dropline) and without any capacitive load at the node connected to the dropline. A real CAN-bus has several droplines distributed along the main bus-line, where each installed node has some kind of capacitive/ inductive load. If the intention is to run the

communication at 5 Mbit/s the graph in figure 21 shows that any dropline above 2 meters is a potential source of problems. How large this problem is depending on the number of droplines and how they are distributed along the main bus-line as well as the load caused by the circuit in the nodes connected to the of the dropline.

The figure also indicates that any bitrate below 1 Mbit/s can work even with droplines above 10 meters.

How to secure a CAN-bus for higher bitrate

As shown in the previous part it should be obvious that a communication cable with droplines is a complicated circuit to analyze because each cable segment must be treated as a unique component. In the worst case the CAN-bus built with different types of cable segments all with different behavior. If one segment has an impedance of 105 Ohm and is connected to a cable segment with 95 Ohm, energy will be reflected between the two segments. This is not as bad as a dropline, that for signal in 100 Ohm transmission lines are identical to a 50 Ohm load which will cause a huge reflection. The signal ignores if the impedance along the cable is 80 Ohm or 120 Ohm if there is no variation throughout the length of the cable. The problem is a variation in the impedance over the length of the cable. One reason for impedance change is temperature variation. Such variation could occur in the winter where one part of the cable could be at -40 C in the chassis but at +20 C in the cabin and even warmer in the engine compartment.

There is a suggestion to define a Spice model of the CAN-bus system, but that alone has some limitations.

1. It is very hard to make a perfect model of the real system.
2. The model will have many components (if it is a realistic model) which will take time to simulate.
3. The transmission line models are hard to model to the real-world behavior, like different temperatures.

4. A Spice simulation does not directly provide test parameters to compare with the real network.

This does not exclude the use of Spice because many such simulators can use S-parameters as input and produce S-parameters for a simulated section that can be compared with measurements in the real environment.

The main advantages with Spice are during development to better understand how different modification in the circuit layout will affect the system. At some stage in the development, it will be necessary to move back to the real world. For example, a node will be relatively complex with connectors, PCB layout, EMC-filter, and the CAN receiver. Instead of making the model it is possible to make a measurement to achieve the S-parameters covering the signal from the dropline connection at the main CAN-bus including the node connected at the end of the dropline. This measurement can be done under different conditions, like different temperature, different voltage supply, or unpowered. If there is any difference it will be possible to use different black-box for different system simulation or use the worst case black-box.

The problem to utilize this type of approach today is the lack of tools. There are expensive tools that can be used, for example ADS, from Keysight, and HFSS, from Ansys. If you have access to Signal integrity tools from Matlab, HyperLynx, Cadence, etc., they can also include the tools to be used for this type of problem. The problem is that those tools are generic tools designed for PCB and backbone problems above 1 GHz and not for a CAN-bus running below 50 MHz. There are some free tools that can be used but they demand some education and training to solve the problem. Most of the figures in this paper come from a free software SignalIntegrityApp that can be downloaded from github. This software can do simulations and process S-parameters but it does not yet directly support the conversion from S-parameters from a VNA (Vector Network Analyzer) to a simulation block.

References:

<https://www.signalintegrityjournal.com/> is a perfect source for more information about Signal Integrity, but most information demand subscription.

“Signal and Power Integrity – Simplified 3rd edition” By Eric Bogatin. There are several books about signal integrity but to me this is the best. To complete the knowledge there are also books by Howard Johnson and others. Chapter 12 in this book covers most you need to know about S-parameters. To get deep knowledge read the book “S-parameters for Signal Integrity”.

“S-parameters for Signal Integrity” by Peter J. Pupalaiakis ISBN 978-1-108-48996-6. This book is the reference to the software package (SignalIntegrity) written in Python. This is a perfect book to understand the mathematics behind S-parameters and the SignalIntegrityApp.

<https://github.com/TeledyneLeCroy/SignalIntegrity> the Python source code and application as described in the book “S-parameters for Signal Integrity”.

For both ADS and HFSS there are many YouTube videos describing how S-parameters can be used to and from simulation and how S-parameters from a VNA can be processed and analyzed.

Kent Lennartsson
Kvaser
Aminogatan 25
SE-431 53 Mölndal
www.kvaser.se